

# powerbass®

X T R E M E



3XL-810D  
3XL-820D  
3XL-1210D  
3XL-1220D  
3XL-1510D  
3XL-1520D

---

**3XL SUBWOOFER SERIES**

**Application Guide**





## Thank you and Congratulations

Congratulations on your decision to purchase PowerBass Xtreme 3XL Series Subwoofer. These top-of-the-line subwoofers are the result of years of extensive engineering and testing, resulting in the finest car audio subwoofers you can purchase today.



At PowerBass USA, Inc. we are confident you will have many years of outstanding enjoyment from your investment. For maximum performance we recommend that you have your new PowerBass Xtreme product installed by an Authorized PowerBass Xtreme Dealer. Doing so will also automatically extend your warranty to a full THREE-YEAR Period.

To learn more about PowerBass Xtreme, please visit us on the World Wide Web at <http://www.powerbassusa.com>

### Δ Warning Δ

Continuous exposure to sound pressure levels in excess of 100 dB can cause permanent hearing loss. PowerBass Xtreme Speakers are capable of producing sound pressure levels well over 170 dB. Please observe all local sound ordinances while listening to your PowerBass Xtreme system. PowerBass USA, Inc. accepts no liability for hearing loss, bodily injury, or property damage due to the result of use or misuse of this product.

## CAUTION

### **To prevent damage to your speakers, please observe the following caution:**

Your PowerBass Xtreme Subwoofer is made with the highest quality materials designed for years of trouble free performance. However, damage to the speaker can occur when the amplifier, regardless of output power, is made to play at levels higher than it was intended. At high volume levels, if the music sounds distorted lower the volume. The audible distortion you hear is probably originating in the amplifier which can cause the speaker cone to move out of control and force the voice coil to bottom out and slam against the magnet assembly. Under these circumstances it will be necessary to lower the volume to just below the point where these symptoms occur to avoid damage to the speaker. If your amplifier has a gain control, it would be advisable to lower this control slightly to prevent this from reoccurring.

If more volume or a higher SPL (Sound Pressure Level) is desired, you should try adding additional speakers to the system. By doing so, it is possible to gain significant increases in sound pressure levels. In some cases, you may double the system's output without any deterioration in sound quality.

## REMINDER

- **This speaker is heavy, so use caution when installing or handling it.**
- **The subwoofer enclosure must be securely & directly attached to the vehicle.**
- **Speakers will become very hot when the system is operated at high power continuously for a long period of time. Never directly touch the speakers with your bare hands until the speakers have cooled.**
- **Never connect only one voice coil of this Dual Voice Coil (DVC) speaker. BOTH voice coils must be connected to the amplifier for correct operation.**

## **POWERBASS XTREME 3XL WOOFER FEATURES**

**DDC Multi-Layered Non-Pressed Paper Cone with Pulp Fibers Reinforcements** for Xtreme lower frequency extension and unrivaled bass output, this multi-layered cone ensure maximum power handling and deep pounding bass

**Custom Cast Aluminum Basket** provides the best woofer foundation available to handle the stress of high energy SPL

**Dual 1-ohm or dual 2-ohm Voice Coils** made with pure CCAW wire and looped through the spider

**3.5" (3XL-1510D/3XL-1520D) BASV Voice Coil Former**

**3.0" (3XL-1210D/3XL-1220D) BASV Voice Coil Former**

**2.5" (3XL-810D/3XL-820D) BASV Voice Coil Former**

**High Roll Foam Surround** allows maximum excursion while maintaining the precise centering of the voice coil resulting in higher undistorted output

**Xtra Xtra Xtra Large Motor Structures** high efficiency double stacked Y-35 strontium ferrite magnet are used to ensure optimum motor force

**Spring Loaded Nickel Plated Input Terminals** to ensure maximum current transfer from your amplifier to your subwoofer

**Custom Tooled Trim Ring** clamps surround to basket for increased durability

**Optimally Designed for both Sealed and Ported Enclosures** to ensure maximum power handling with the loudest output possible

## WIRING GUIDELINES

It is highly recommended that you seek an authorized PowerBass dealer to properly setup, wire and install your woofers for maximum performance.

All PowerBass Xtreme 3XL Series Subwoofers use dual voice coils. The use of dual voice coils offers you more versatility in system configuration. It is important to know the limits of your amplifier to optimize its performance. It is always better to use your subwoofer in a mono / bridged mode if your amplifier has the capabilities. There are basically four different types of wiring configurations: Series, Parallel, Series-Parallel or Parallel-Parallel. It is possible to change the impedance or load by how the speakers are to be wired and by the quantity of woofers used.

### DUAL 1-OHM VOICE COIL WIRING

#### PARALLEL

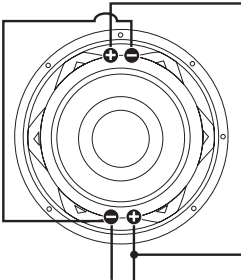

#### Amplifier

Parallel wiring a dual 1 ohm sub = 1/2 ohm

#### SERIES

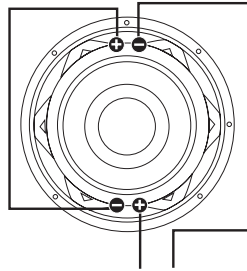

#### Amplifier

Series wiring a dual 1 ohm sub = 2 ohm

#### PARALLEL-PARALLEL

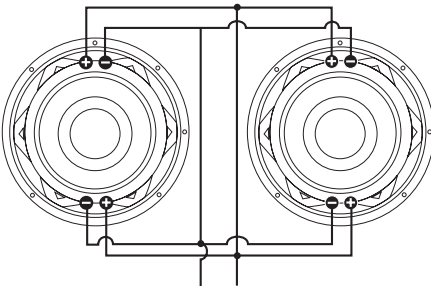

#### Amplifier

Parallel-Parallel wiring two dual 1 ohm subs = 1/4 ohm

#### SERIES-PARALLEL

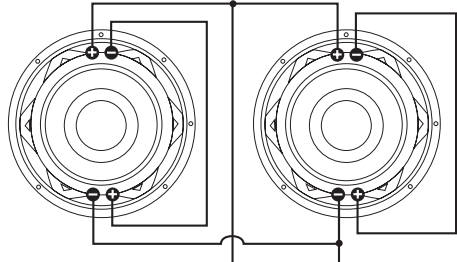

#### Amplifier

Series-Parallel wiring two dual 1 ohm subs = 1 ohm

## DUAL 2-OHM VOICE COIL WIRING

### PARALLEL

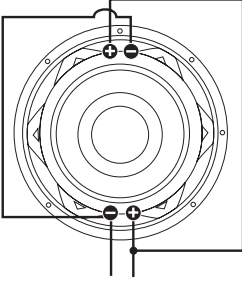

### Amplifier

Parallel wiring a dual 2 ohm sub = 1 ohm

### SERIES

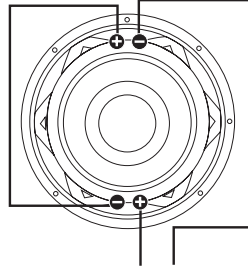

### Amplifier

Series wiring a dual 2 ohm sub = 4 ohm

### SERIES-PARALLEL

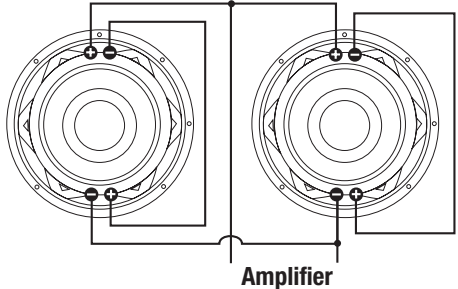

### Amplifier

Series-Parallel wiring two dual 2 ohm subs = 2 ohm

**NOTE: Never connect only one coil of a Dual Voice Coil (DVC) speaker. BOTH voice coils must be connected to the amplifier**



### Tech Support

8:30am-5:30pm Pacific Time  
(909) 923-3868  
[www.powerbassusa.com](http://www.powerbassusa.com)

## INSTALLATION EXPERIENCE

Installation of PowerBass Xtreme Speakers requires experience with a variety of mechanical and electrical procedures. This manual provides only general installation and operation instructions. If you have any reservations about your installation skills or lack of the proper tools, please contact your local PowerBass Xtreme dealer for assistance.

### CHOOSING A SPEAKER ENCLOSURE

The PowerBass Xtreme 3XL Subwoofers are engineered to perform at their optimum level in a Vented (aka Ported) enclosure. However, these subwoofers offer the versatility of being used in either sealed, vented or bandpass enclosures. For maximum performance we recommend you have your new PowerBass Xtreme Subwoofer installed by an Authorized PowerBass Xtreme Dealer.

- **SEALED BOX:** A sealed or acoustic suspension enclosure is easy to build and typically offers a smaller size enclosure and greater power handling. It has the most predictable frequency and phase response; the bass response will roll off slower than that of a ported design. Sealed boxes typically provide the best musical detail and definition. A well-designed sealed enclosure will exhibit smooth frequency response with excellent sound quality and great low bass extension. They also exhibit relatively accurate, punchy bass reproduction for most types of music. If a sealed enclosure is too large to fit into a specific area of a vehicle, it is possible to decrease the recommended box volume by using 1.5 pounds per cubic feet of low density, high heat specific box stuffing material. PowerBass recommends Fiberglass, Dacron, Poly-Fill or long fiber wool for stuffing the enclosure (decreasing the box enclosure however should not exceed 20% of the recommended size). When using any type of box stuffing material be sure that the subwoofer's vented pole piece is clear from any obstructions, since covering the pole piece will result in loss of bass and can possibly cause damage to your subwoofer. The most important aspect of a sealed enclosure is to make sure that it is airtight and solid. If your enclosure has any air leaks or if the panels vibrate or flex, you will experience a loss of bass output. Using glue and some type of sealant (caulk) on all seams will ensure a solid constructed box without any air leaks.
- **VENTED BOX:** Also known as a ported or bass reflex enclosure, this type of box is almost as easy to construct as a sealed enclosure. This design however is more efficient and results in an increase of bass output at certain frequencies. Although a vented enclosure has an output advantage at some frequencies, it also has a steeper rolloff, which will only affect bass frequencies below port tuning. Air inside the port will move in phase with the subwoofer reinforcing frequencies above the F3 (-3dB point). The SPL advantage of the vented enclosure comes from the fact that the effect of the vent tuning reduces the excursion of the subwoofer near the tuning frequency allowing more SPL to be produced before the subwoofer bottoms. Damping material should also be used to line the internal walls to reduce any sonic reflection. Because of the characteristics of a vented enclosure, subwoofers typically will become unloaded (act as if it is not in a box) at frequencies of  $\frac{1}{2}$  octave below the enclosure tuning frequency. Using a high pass filter / subsonic filter will help prevent the subwoofer from unloading or exceeding its excursion capabilities. It is important to stay within the recommended enclosure specifications. (PowerBass recommends port placement to coincide on the same panel or baffle that the subwoofer resides on.)



- BANDPASS ENCLOSURE:** The most common bandpass enclosure is a combination of a sealed and a vented enclosure working together (4th order or single reflex bandpass system). The rear of the speaker goes into the sealed chamber while the front of the speaker goes into the vented chamber. Because the vent produces all the sound generated from this type of enclosure, sound quality may not be as good as a well-designed ported or sealed design. Often the sacrifice for sound quality and subwoofer cone control is greater SPL output. However unlike a sealed or vented enclosure, you can effectively increase the enclosure sensitivity with the appropriate tuning choices. You can choose to design a narrow frequency band with very high sensitivity or choose a wide frequency band with the sacrifice of lower sensitivity. The damping effect of the vented chamber reduces the motion of the cone so that potentially higher sound output is achieved without the subwoofer reaching its mechanical limits. Minor deviations from design recommendations however may result in frequency response and distortion problems.

***(If you are intending to use multiple subwoofers in your system, PowerBass recommends having separate chambers for each subwoofer if the subwoofers will be operated by two different amplified signals. This will prevent any possible cancellation.)***

***NOTE: Due to the vented backplate, you must allow an additional 2" behind the subwoofer when designing your speaker enclosure.***

**CAUTION:** If the air volume of the speaker enclosure is larger then the recommended size or used alone in a free air application will cause serious damage. It will not only deteriorate in durability, but eventually stop functioning.

## ENCLOSURE VOLUME

To calculate the volume required for your enclosure please refer to the Recommended Enclosures section of this guide for your specific model number. These are listed in both cubic feet and liters. One cubic foot is expressed as  $12" \times 12" \times 12" = 1728$  cubic inches (see picture below).

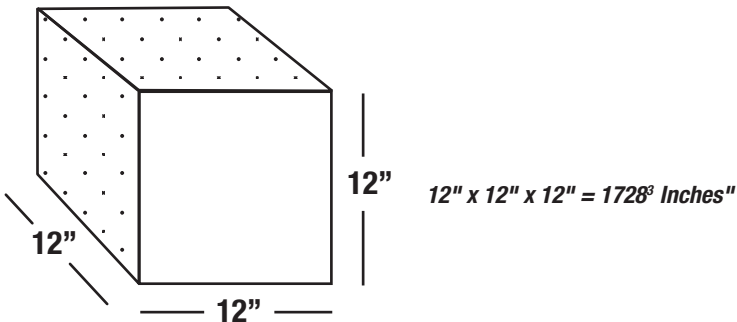

## TIPS TO GET THE MOST OUT OF YOUR 3XL WOOFER

Your PowerBass Xtreme subwoofer has been meticulously engineered and designed to handle high power musical reproduction. Despite their rugged construction, it is possible to damage your speaker if they are improperly used. In general, you will hear distortion as a so-called warning before any damage occurs. If you hear distortion in your system, immediately reduce the musical level to the point where the sound retains its clarity.

1. All PowerBass Xtreme subwoofers require an initial break-in period before it will reach optimum performance. Like any new precision machinery, allow a minimum of several days to one week with normal daily usage to ensure that the suspension has properly been broken-in.
2. Never use only one coil on a dual voice coil subwoofer. Doing so will significantly decrease the efficiency and power handling of the speaker.
3. Be sure you supply the speakers with enough unclipped amplifier power to drive them properly. (More damage can be done to a speaker by under-powering and clipping your amplifier than any other way!)
4. Where possible, run your Speakers in mono instead of stereo. Most bass is reproduced in mono so there is less chance of any cancellation if played in mono.
5. Where possible, wire your Speakers in parallel instead of series. Bass is reproduced either way but again there is less chance of cancellation in parallel. NOTE: Be sure the amplifier you are using is stable to the resulting impedance of the speaker load!
6. Where possible, a separate amplifier just for your subwoofers should be used with an electronic crossover to set the frequency range. One Class D amplifier per 3XL woofer is optimum.
7. Do not block the front of your speakers or ports. You want as much direct air coupling as possible. Also be sure to round off the inside edges of the port to reduce any port noise.
8. For ported enclosures, keep in mind that you must leave at least twice the port diameter size between the subwoofer and the port itself. Leave at least one time the port diameter between the port and any walls of the enclosure.
9. Remember the Golden Rule "Measure twice...cut once."

### BREAK IN PERIOD

To get the most from your woofer we recommend a "break-in" period of at **least 40 hours** at no more than 1/3 of maximum volume.

During this time the cone and spider assembly will gradually break in resulting in greater performance and more listening enjoyment.

## **BOX CONSTRUCTION (SEALED OR VENTED)**

The material used for enclosure walls should be solid, dense and free of voids or warps. Your enclosure should be made  $\frac{3}{4}$ " or 19mm material, Finland or Baltic birch type plywood is recommended where the enclosure will be transported frequently.

Medium-density fiberboard - MDF (not chip board) can be used on permanently installed systems. Minimum of 1" (25mm) or double  $\frac{3}{4}$ " (1-1/2") baffle is recommended on high-powered SPL applications. Corners must be strong and air tight and should not have any air leaks or openings. Joints should be properly filled with glue that will not crack under high stress or impact. If the integrity of the glue seal can't be determined, hot glue or RTV caulking should be used to seal all seams.

Fiber reinforced resin may also be used to form any difficult shapes. However avoid making large panels with resin to eliminate any chances of box flexing, cracking or ratting under high pressure. Bracing made of 2 x 2" or 2 x 4" should be liberally applied either inside or outside the cabinet, depending on whether the cabinet is to be permanently installed or portable.

This principle applies to any walls of the enclosure spanning more than 18" long. Any braces should also be liberally glued or screwed down on edge. Edge-wise drilled, and countersunk holes through the braces can be used for #10-2 Flathead wood screws to avoid the use of more expensive lag bolts. The majority of strength from an enclosure comes from the glue. When using screws be sure to pre-drill holes to avoid splitting the wood.

***WARNING! The use of silicone rubber to seal in a speaker will void the Warranty! If any sealing is needed in addition to the speaker's gasket, use caulking cord or vinyl weather strip.***

## **SUBWOOFER CROSSOVER SETTING**

Your PowerBass Xtreme Subwoofer will perform best if it is used in conjunction with a subwoofer crossover of some kind. Using a crossover will remove unwanted high frequencies and allow them to concentrate only on bass. The two most common types of crossovers are "passive" or "active" (electronic crossovers are active).

Many amplifiers have a built in Low Pass (LPF) electronic crossover circuit. For optimum subwoofer performance we recommend an initial electronic crossover setting between 80-100Hz and then tuning the bass to your liking.

## PARAMETERS FOR POWERBASS 3XL SERIES SUBWOOFER

(Due to Constant Improvements, Specifications and Parameters are subject to change without notice.)

	3XL-810D	3XL-820D	3XL-1210D	3XL-1220D
<b>VC Impedance (ohms)</b>	Dual 1-0HM	Dual 2-0HM	Dual 1-0HM	Dual 2-0HM
<b>Test Impedance (ohms)</b>	0.51	1.15	1.83	4.00
<b>Fs (Hz)</b>	50.0	52.6	35.5	35.1
<b>SD (sqCM)</b>	213.82	213.82	530.93	530.93
<b>Vas (Ltr)</b>	4.87	4.59	26.00	27.96
<b>Cms (µM/N)</b>	73	71	65	70
<b>Mms (g)</b>	134.67	119.55	308.79	292.92
<b>BL™</b>	5.009	7.785	14.06	18.99
<b>Qms</b>	4.483	4.540	5.932	5.533
<b>Qes</b>	0.854	0.776	0.639	0.716
<b>Qts</b>	0.717	0.663	0.577	0.599
<b>No (%)</b>	0.069	0.083	0.175	0.163
<b>Spl (dB) 1W/1M</b>	80.57	81.88	85.0	84.32
<b>SPL (dB) 2.8V/1M</b>	92.49	90.25	89	88
<b>One-Way Xmax (mm)</b>	12	12	19	19
<b>Voice Coil Size (inches)</b>	2.5 (63mm)	2.5 (63mm)	3.0 (76mm)	3.0 (76mm)
<b>Frequency Response (Hz)</b>	43-500	43-500	25-450	25-450
<b>Magnet Weight (ounces)</b>	80 oz.	80 oz.	228.46 oz.	228.46 oz.
<b>Mounting Depth (inches)</b>	6.125" (156mm)	6.125" (156mm)	9.1" (232mm)	9.1" (232mm)
<b>Speaker Displacement</b>	0.064 cu.ft (1.81L)	0.064 cu.ft (1.81L)	0.092 cu.ft (2.61 L)	0.092 cu.ft (2.61 L)
<b>Power (RMS/Peak)</b>	500/750 watts	500/750 watts	1000/2000 watts	1000/2000 watts

## POWER RECOMMENDATIONS

Many speaker and amplifier brands measure their power ratings in different ways. Often the stated "Max Power handling" are viewed as continuous RMS power handling of the speaker, when actually the "Max" is generally the breaking point of the speaker. In an effort to minimize any confusion, PowerBass has chosen to rate our Super Subs in the following manner:

**NOMINAL POWER HANDLING** Playing your woofer at levels below the Pe-RMS spec will allow the woofer to operate at optimum conditions and cause the speaker minimal mechanical degradation over time.

**Pe-RMS POWER HANDLING** Pe-RMS is the highest power rating we assign the woofer for continuous use under normal conditions. Exceeding this power level for extended durations will result in mechanical degradation that may lead to possible failure over time.

**Pe-MAXIMUM POWER HANDLING** Pe-Maximum is the maximum power rating the woofer can handle for short bursts or peak transients with clean input power. Exceeding this power level or using dirty (distorted input power) will cause thermal failure that will void the speaker warranty.

## PARAMETERS FOR POWERBASS 3XL SERIES SUBWOOFER

(Due to Constant Improvements, Specifications and Parameters are subject to change without notice.)

	<b>3XL-1510D</b>	<b>3XL-1520D</b>
<b>VC Impedance (ohms)</b>	Dual 1-OHM	Dual 2-OHM
<b>Test Impedance (ohms)</b>	1.99	4.02
<b>Fs (Hz)</b>	29.4	29.6
<b>SD (sqCM)</b>	881.41	881.41
<b>Vas (Ltr)</b>	80.38	69.04
<b>Cms (µM/N)</b>	73	63
<b>Mms (g)</b>	462.75	460.35
<b>BL™</b>	17.86	23.67
<b>Qms</b>	5.082	6.410
<b>Qes</b>	0.496	0.614
<b>Qts</b>	0.452	0.561
<b>No (%)</b>	0.319	0.280
<b>Spl (dB) 1W/1M</b>	87.27	86.67
<b>SPL (dB) 2.8V/1M</b>	91	90
<b>One-Way Xmax (mm)</b>	24	24
<b>Voice Coil Size (inches)</b>	3.5 (89mm)	3.5 (89mm)
<b>Frequency Response (Hz)</b>	25-400	25-400
<b>Magnet Weight (ounces)</b>	370.23 oz.	370.23 oz.
<b>Mounting Depth (inches)</b>	11.2" (282mm)	11.2" (282mm)
<b>Speaker Displacement</b>	0.175 cu.ft (4.96 L)	0.175 cu.ft (4.96 L)
<b>Power (RMS/Peak)</b>	1,500 / 3,000 watts	1,500 / 3,000 watts



## RECOMMENDED ENCLOSURES

Please note that these enclosure volume recommendations are for the internal airspace inside the enclosure and include the displacement of the subwoofer and ports. When choosing your enclosure type, please pay close attention to your specific woofer, failing to use the correct enclosure may result in lower power handling and poor sound quality. **To calculate the internal airspace required, take the internal dimensions of the box. First multiply these number by themselves and then divide this sum by 1728. (W x H x D) / 1728.**

Please contact your authorized PowerBass dealer for other designs and specifications.

### 3XL-810D/3XL-820D

SEALED ENCLOSURES	Minimum Volume	Recommended Volume	Maximum Volume
Sealed Box Gross* (cu.ft / liters)	0.4 cu ft. / 11.3 L	0.6 cu ft. / 17.1 L	1.0 cu ft. / 28.2 L
F-3 (-3 dB roll off Hz)	53	51	51
Qtc	0.841	0.785	0.749
Driver Displacement (cu.ft / liters)	0.064 cu ft. / 1.81 L	0.064 cu ft. / 1.81 L	0.064 cu ft. / 1.81 L
External Dimensions of Enclosure WxHxD 0.75 (19mm) MDF (inch / cm )	10" x 11" 10" 25.4 x 27.9 x 25.4 cm	12" x 13" 10" 30.5 x 33.0 x 25.4 cm	14" x 14" 12.5" 35.6 x 35.6 x 31.8 cm
Pe (Watts RMS)	200-500 watts	200-500 watts	200-500 watts

PORTED ENCLOSURES	Minimum Volume	Recommended Volume	Maximum Volume
Ported Box Gross* (cu.ft / liters)	0.75cu ft. / 21.2 L	1.0 cu ft. / 28.2 L	1.25 cu ft. / 35.79 L
Round Port (inch / cm)	3" / 7.62 cm	3" / 7.62 cm	3.5" / 8.9 cm
Round Port Length**	11" / 27.94 cm	8.5" / 21.6cm	12" / 30.5 cm
Round Port Displacement (cu.ft / liters)	0.049 cu ft. / 1.39 L	0.0377 cu ft. / 1.07 L	0.072 cu ft. / 2.04 L
Slot Port Opening (inch / cm)	1.0" x 8.5" 2.5 x 21.6 cm	1.0" x 10" 2.5 x 25.4 cm	1.0" x 10.5" 2.5 x 26.7 cm
Slot Port Length (inch / cm)***	20.75" / 52.7 cm	18.25" / 46.3 cm	17.5" / 44.5 cm
Slot Port Displacement (cu.ft / liters)	0.22 cu ft. / 6.2 L	0.223 cu ft. / 6.3 L	0.223 cu ft. / 6.3 L
Port Tuning (Hz)	48 Hz	45 Hz	40 Hz
Driver Displacement (cu.ft / liters)	0.064 cu ft. / 1.81 L	0.064 cu ft. / 1.81 L	0.064 cu ft. / 1.81 L
Subsonic Filter Setting (Hz)	38 Hz	35 Hz	30 Hz
External Dimensions of Enclosure WxHxD 0.75 (19mm) MDF (inch / cm )	11.5" x 14.5" x 11.5" 29.2 x 36.8 x 29.2 cm	13" x 14" x 13.5" 33 x 35.6 x 34.31 cm	13.5" x 14.5" x 15.5" 34.3 x 36.8 x 39.4 cm
F-3 (-3 dB roll off Hz)	38 Hz	35 Hz	29 Hz
Pe (Watts RMS)	200-500 watts	200-500 watts	200-500 watts

\* Gross enclosure volume includes Port and speaker displacements.

\*\* Round ports may not fit on the same baffle as the driver (use the bottom rear corner of either side panel)

\*\*\* Slot port length may require "L" extension

## RECOMMENDED ENCLOSURES

Please note that these enclosure volume recommendations are for the internal airspace inside the enclosure and include the displacement of the subwoofer and ports. When choosing your enclosure type, please pay close attention to your specific woofer, failing to use the correct enclosure may result in lower power handling and poor sound quality. **To calculate the internal airspace required, take the internal dimensions of the box. First multiply these number by themselves and then divide this sum by 1728. (W x H x D) / 1728.**

Please contact your authorized PowerBass dealer for other designs and specifications.

### 3XL-1210D/3XL-1220D

SEALED ENCLOSURES	Minimum Volume	Recommended Volume	Maximum Volume
Sealed Box Gross* (cu.ft / liters)	1.0 cu ft. / 29.3 L	1.5 cu ft. / 42.5 L	2.0 cu ft. / 56.6 L
F-3 (-3 dB roll off Hz)	46	45	44
Qtc	0.780	0.713	0.676
Driver Displacement (cu.ft / liters)	0.092 cu ft. / 2.6 L	0.092 cu ft. / 2.6 L	0.092 cu ft. / 2.6 L
External Dimensions of Enclosure WxHxD 0.75 (19mm) MDF (inch / cm )	15" x 14" 12" 38.1 x 35.6 x 30.5 cm	17" x 15" 14" 43.2 x 38.1 x 35.6 cm	18" x 17" 15" 45.7 x 43.2 x 38.1 cm
Pe (Watts RMS)	700-1000 watts	700-1000 watts	700-1000 watts

PORTED ENCLOSURES	Minimum Volume	Recommended Volume	Maximum Volume
Ported Box Gross* (cu.ft / liters)	2.0 cu ft. / 56.6 L	2.5 cu ft. / 70.8 L	3.0 cu ft. / 87.0 L
Round Port (inch / cm)	5" / 12.7 cm	5" / 12.7 cm	5" / 12.7 cm
Round Port Length**	18.5" / 47.0 cm	16" / 40.6 cm	14.5" / 36.8 cm
Round Port Displacement (cu.ft / liters)	0.222 cu ft. / 6.3 L	0.191 cu ft. / 5.4 L	0.172 cu ft. / 4.9 L
Slot Port Opening (inch / cm)	1.25" x 13.5" 3.2 x 34.3 cm	1.5" x 12.5" 3.8 x 31.8 cm	1.5" x 13.5" 3.8 x 34.3 cm
Slot Port Length (inch / cm)***	19.5" / 49.5 cm	19" / 48.3 cm	20" / 50.8 cm
Slot Port Displacement (cu.ft / liters)	0.448 cu ft. / 13.8 L	0.444 cu ft. / 12.6 L	0.501 cu ft. / 14.2 L
Port Tuning (Hz)	38 Hz	35 Hz	32 Hz
Driver Displacement (cu.ft / liters)	0.0923 cu ft. / 2.6 L	0.0923 cu ft. / 2.6 L	0.0923 cu ft. / 2.6
Subsonic Filter Setting (Hz)	30 Hz	30 Hz	30 Hz
External Dimensions of Enclosure WxHxD 0.75 (19mm) MDF (inch / cm )	22" x 15" x 14" 55.9 x 38.1 x 35.6 cm	24" x 14" 17" 60.9 x 35.6 x 43.2 cm	24" x 15" 19" 61 x 38.1 x 48.3 cm
F-3 (-3 dB roll off Hz)	31 Hz	28 Hz	27 Hz
Pe (Watts RMS)	700-1000 watts	700-1000 watts	700-1000 watts

\* Gross enclosure volume includes Port and speaker displacements.

\*\* Round ports may not fit on the same baffle as the driver (use the bottom rear corner of either side panel)

\*\*\* Slot port length may require "L" extension

## 3XL-1510D/3XL-1520D

SEALED ENCLOSURES	Minimum Volume	Recommended Volume	Maximum Volume
Sealed Box Gross* (cu.ft / liters)	1.75 cu ft. / 49.6 L	2.25 cu ft. / 63.7 L	2.75 cu ft. / 77.9 L
F-3 (-3 dB roll off Hz)	45	44	43
Qtc	0.726	0.670	0.631
Driver Displacement (cu.ft / liters)	0.175 cu ft. / 5.0 L	0.175 cu ft. / 5.0 L	0.175 cu ft. / 5.0 L
External Dimensions of Enclosure WxHxD 0.75 (19mm) MDF (inch / cm )	18" x 16" 14.25" 45.7 x 40.6 x 36.2 cm	19" x 18" 15" 48.3 x 45.7 x 38.1 cm	18" x 17" 15" 50.8 x 48.3 x 41.3 cm
Pe (Watts RMS)	1000-1500 watts	1000-1500 watts	1000-1500 watts

PORTED ENCLOSURES	Minimum Volume	Recommended Volume	Maximum Volume
Ported Box Gross* (cu.ft / liters)	2.75 cu ft. / 77.9 L	3.5 cu ft. / 99.1 L	4.0 cu ft. / 113.3 L
Round Port (inch / cm)	2 x 4" / 2 x 10.2 cm	6" x 15.2 cm	6" x 15.2 cm
Round Port Length**	17" / 43.2 cm	16" / 40.6 cm	15.5" / 39.4 cm
Round Port Displacement (cu.ft / liters)	0.267 cu ft. / 7.6 L	0.271 cu ft. / 7.7 L	0.267 cu ft. / 7.6 L
Slot Port Opening (inch / cm)	1.5" x 15" 3.8 x 38.1 cm	1.75" x 15.5" 4.5 x 39.4 cm	2" x 15.5" 5.1 x 61.0 cm
Slot Port Length (inch / cm)***	17" / 43.2 cm	20" / 50.8 cm	24" / 61.0 cm
Slot Port Displacement (cu.ft / liters)	0.480 cu ft. / 13.2 L	0.615 cu ft. / 17.4 L	0.801 cu ft. / 22.7 L
Port Tuning (Hz)	38 Hz	35 Hz	32 Hz
Driver Displacement (cu.ft / liters)	0.175 cu ft. / 5.0 L	0.175 cu ft. / 5.0 L	0.175 cu ft. / 5.0 L
Subsonic Filter Setting (Hz)	30 Hz	30 Hz	30 Hz
External Dimensions of Enclosure WxHxD 0.75 (19mm) MDF (inch / cm )	21" x 16.5 x 18.0" 53.3 x 42 x 45.7 cm	24.5" x 17" 18.5" 62.2 x 43.2 x 47.0 cm	28" x 17" 19" 71.1 x 43.2 x 48.3 cm
F-3 (-3 dB roll off Hz)	32 Hz	30 Hz	28 Hz
Pe (Watts RMS)	1000-1500 watts	1000-1500 watts	1000-1500 watts

\* Gross enclosure volume includes Port and speaker displacements.

\*\* Round ports may not fit on the same baffle as the driver (use the bottom rear corner of either side panel)

\*\*\* Slot port length may require "L" extension





## UNPACKING/REPACKING THE WOOFER

Please refer to the enclosed diagram regarding the unpacking/repacking of your woofer. This very specialized woofer from PowerBass is custom packed from the factory to prevent any shipping damage from occurring to the product. It is important that you follow the separate diagram to unpack/repack your PowerBass subwoofer.

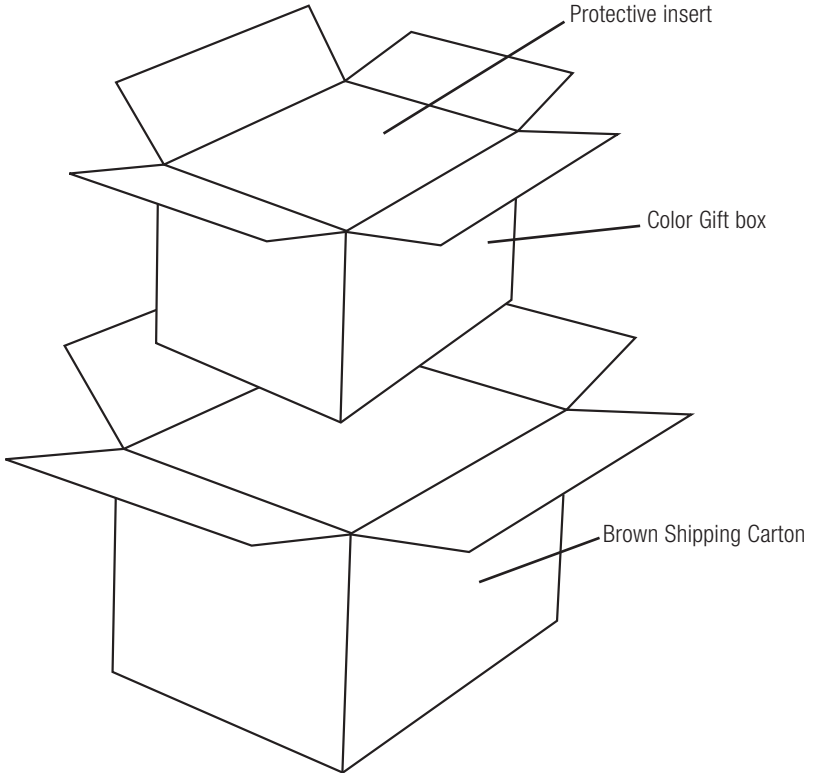

## SAVE YOUR PACKAGING

The PowerBass Xtreme subwoofers are very heavy and therefore require special packaging to assure their unblemished arrival. Should you need to transport your PowerBass Xtreme subwoofer, you must use **both** the color gift box and the brown shipping carton to ensure safe arrival. This special, original packaging must accompany the PowerBass Xtreme subwoofer in the event of product failure.

**NOTE: YOU MUST RETURN THIS PRODUCT IN ALL OF THE ORIGINAL CARTONS TO ASSURE THE WOOFER IS PROPERLY PACKED FOR SHIPPING!**

This manual is the exclusive property of PowerBass USA, Inc. Any reproduction of this manual, or use other than its intentions is strictly prohibited without the express consent of PowerBass USA, Inc. Copyright 2020 PowerBass USA, Inc.

# POWERBASS XTREME LIMITED WARRANTY POLICY

PowerBass USA, Inc. offers limited warranty on PowerBass products under normal use on the following terms:

**PowerBass Xtreme Speakers are to be free of defects in material and workmanship for a period of one (1) year. The warranty is extended to three (3) years for parts and labor, if an Authorized PowerBass Xtreme Dealer completes the installation.**

This warranty applies only to PowerBass products sold to consumers by Authorized PowerBass Dealers in the United States of America. Products purchased by consumers from a PowerBass dealer in another country are covered only by that country's Distributor and not by PowerBass USA.

This warranty covers only the original purchaser of PowerBass product. In order to receive service, the purchaser must provide PowerBass with a valid purchase receipt from an authorized reseller stating the consumer name, dealer, product and date of purchase.

Products found to be defective during the warranty period will be repaired or replaced (with a product deemed to be equivalent) at PowerBass's discretion and will not be liable for incidental or consequential damages. PowerBass will not warranty this product under the following situations:

- **Speakers received with bent frames or water damage**
- **Abuse such as holes in the cone, surround or ripped spider**
- **Voice coil damage due to amplifier clipping or distortion**
- **Product that has not been installed according to this owners manual**

Any implied warranties including warranties of fitness for use and merchantability are limited in duration to the period of the express warranty set forth above. Some states do not allow limitations on the length of an implied warranty, so this limitation may not apply. No person is authorized to assume for PowerBass any other liability in connection with the sale of this product.

**Please call (909) 923-3868 for PowerBass Customer Service.** You must obtain an RA# (Return Authorization Number) to return any product to PowerBass. **The RA number must be prominently marked on the outside of the shipping carton or the delivery will be refused.** Please pack your return carefully; we are not responsible for items damaged in shipping. Return the defective product along with a copy of the original dated retail sales receipt, plus \$12.00 for handling and diagnostic evaluation to:

**PowerBass USA, Inc.,  
Attn: Returns (RA# \_\_\_\_\_)  
2133 S. Green Privado, Ontario, CA 91761**

Residents of HI, AK and US territories will be charged for return shipping. All inquires regarding service and warranty should be sent to the above address.

**Removed or altered serial numbers will void this warranty**





PowerBass Xtreme (PBX) – A division of PowerBass USA, Inc.

2133 S. Green Privado – Ontario, CA 91761

Tel. (909) 923-3868 – Fax (909) 923-8048

**[www.powerbassusa.com](http://www.powerbassusa.com)**